

MODEL B666



DESCRIPTION

The 12 key Z-series keypads are specially designed for public environment applications, such as vending machines, ticket machines, payment terminals, telephones, access control systems and industrial machinery.

Keys and front panel are built from chrome plated zinc alloy (Zamak) with high resistance to impact and vandalism and is also sealed to IP65.

1 MAIN COMPONENTS

- Frame and keys are made of RoHS approved zinc alloy material
- Conductive rubber with carbon granules
 - Contact resistance: $\leq 150\Omega$
 - Elastic force: 200g
- 1.5mm thickness UL approved printed circuit board with golden fingers

2 STRUCTURE DRAWING

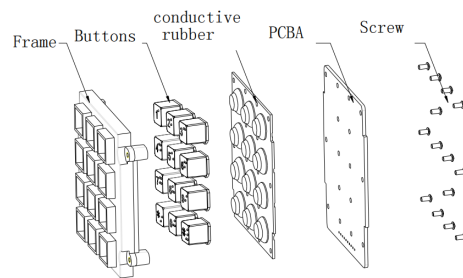

3 DIMENSION DRAWING

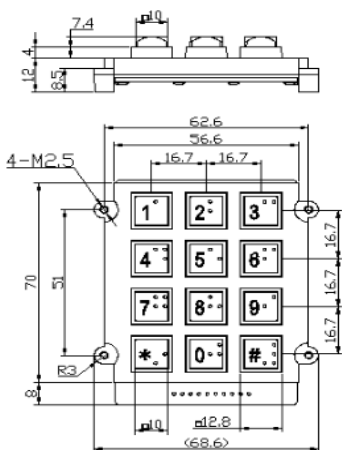

4 COMMON CIRCUIT

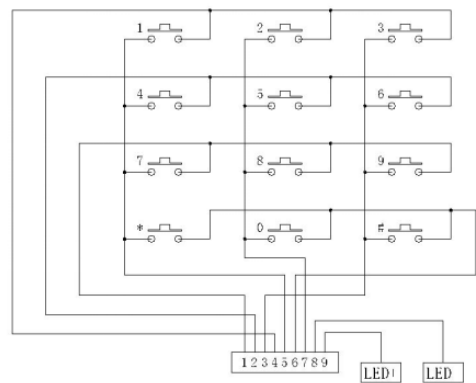

5 SPECIFICATION

Electrical Specification	Power Supply	Nominal 3 VDC	
		Max. voltage 12VDC	
		Min. voltage 3VDC	
	Power Supply	Min. Current 60mA	
Mechanical Characteristics		Standard blue color and white, yellow, green and white color are optional.	
	Contact Resistance	≤150Ω	
	Storage Temperature	-40℃ ... +85℃	
	Operation Temperature	-25℃ ... +65℃	
	Protection Grade	IP65	
	Shock Resistance	IK09	
	Electrical Life	1 million cycles of operation per key	
	Key Travel	0.45mm	
	Environmental Resistance		250g/2.45N
			Damp heat 21 days +40℃
		Saline mist 96 Hours	
		Dry heat 10 days +85℃	

6 CONNECTOR

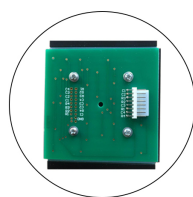

Plug Connector

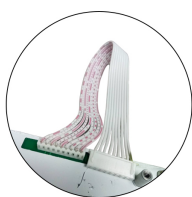

SCN plug+cable



XH plug+cable

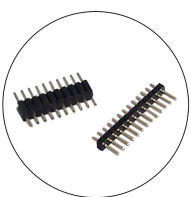

Pins header



DB9 Connector



USB

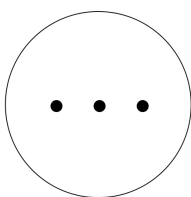

More

7 APPLICATION

